

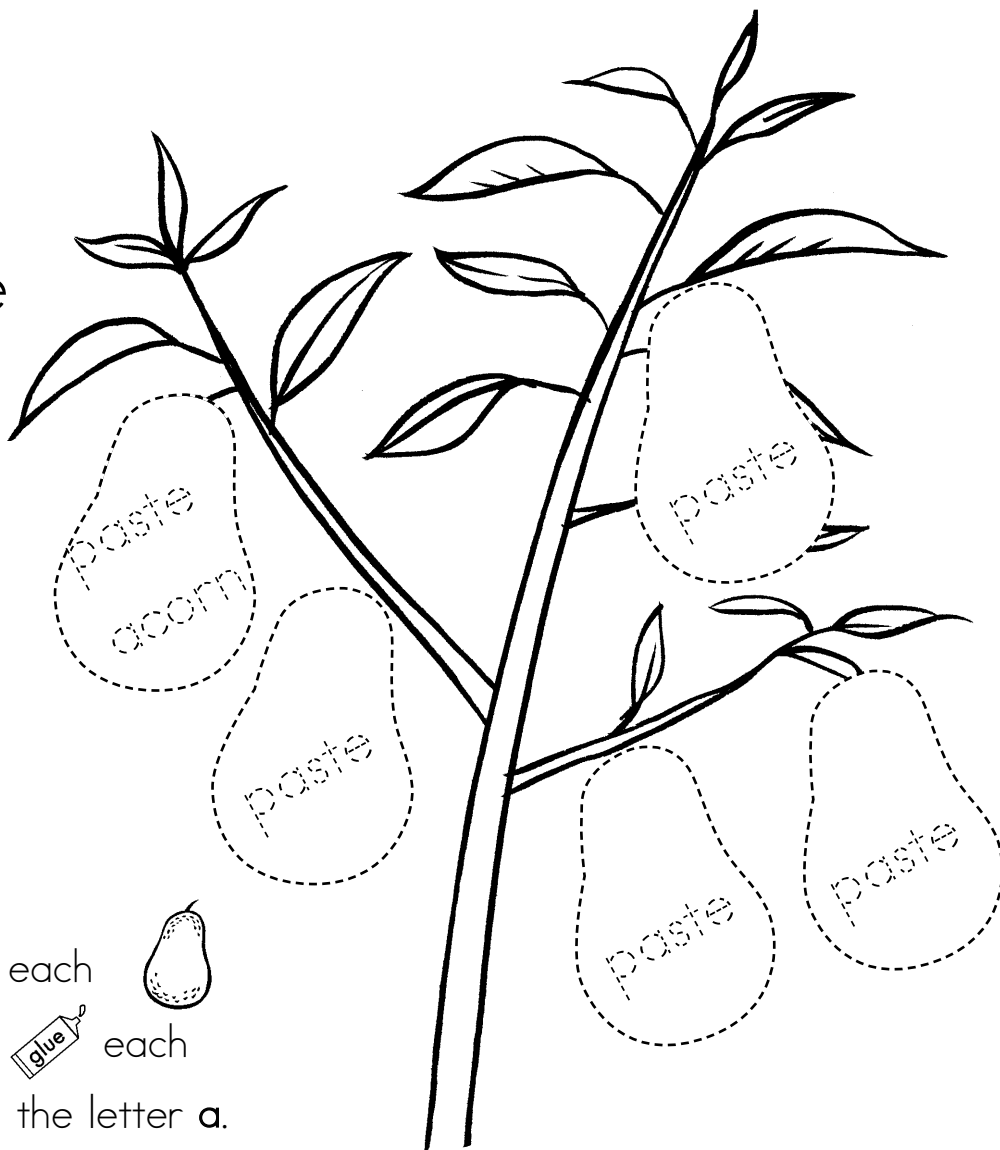



Name _____

A a

avocado tree



Find an "a" picture for each
and  and  and  each
picture that begins with the letter a.

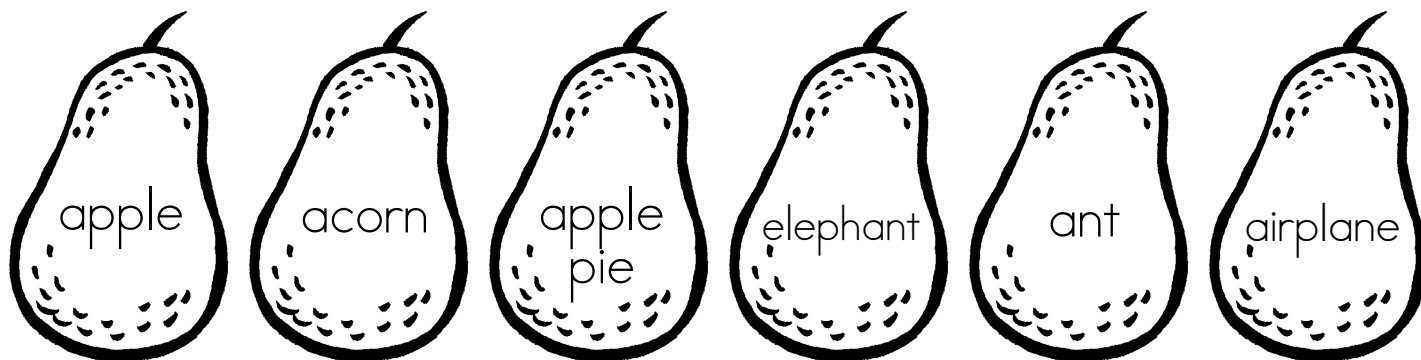

Name _____

B b



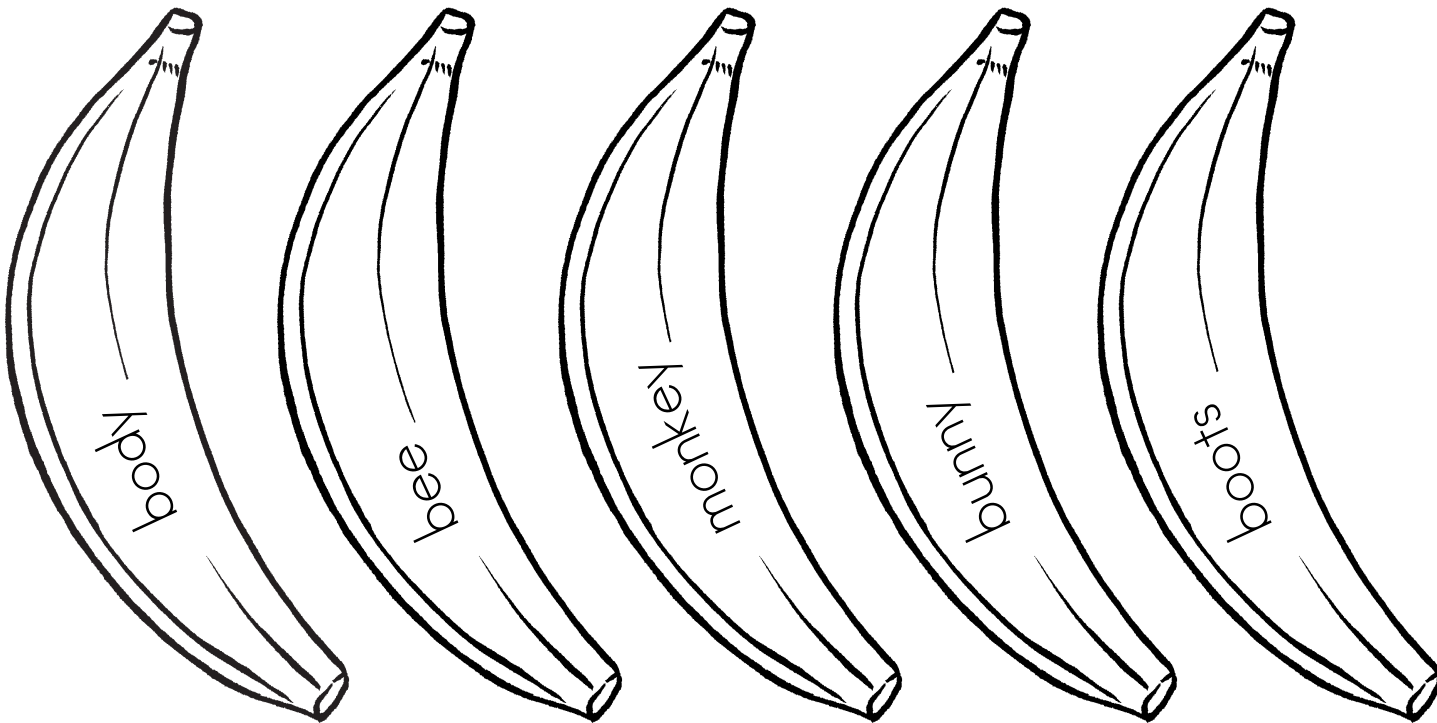
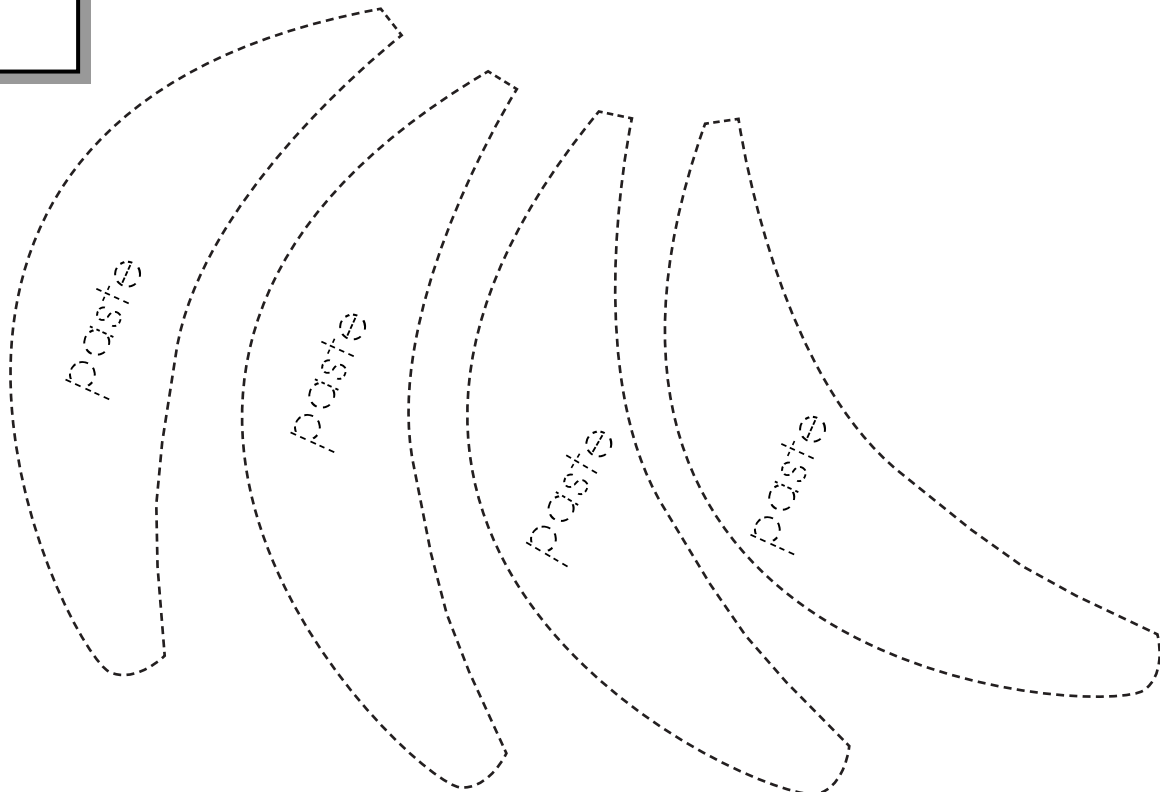

Find a "b" picture for each  and  and 
and  each picture that begins with the letter b.

bananas

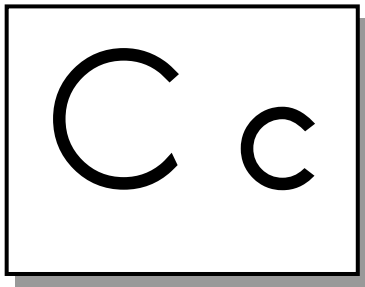

Name _____



Find a "c" picture for each  and  and  and  each picture that begins with the letter c.

castle

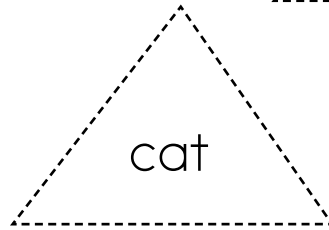
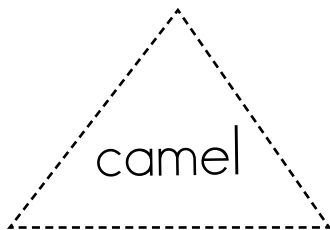
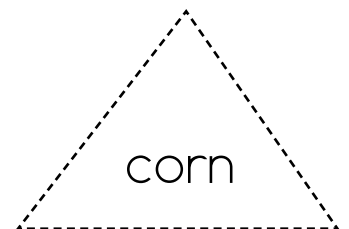
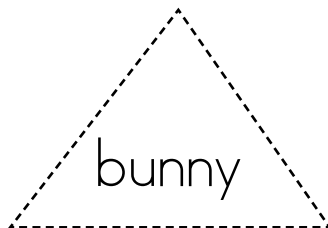
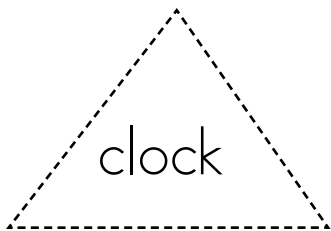
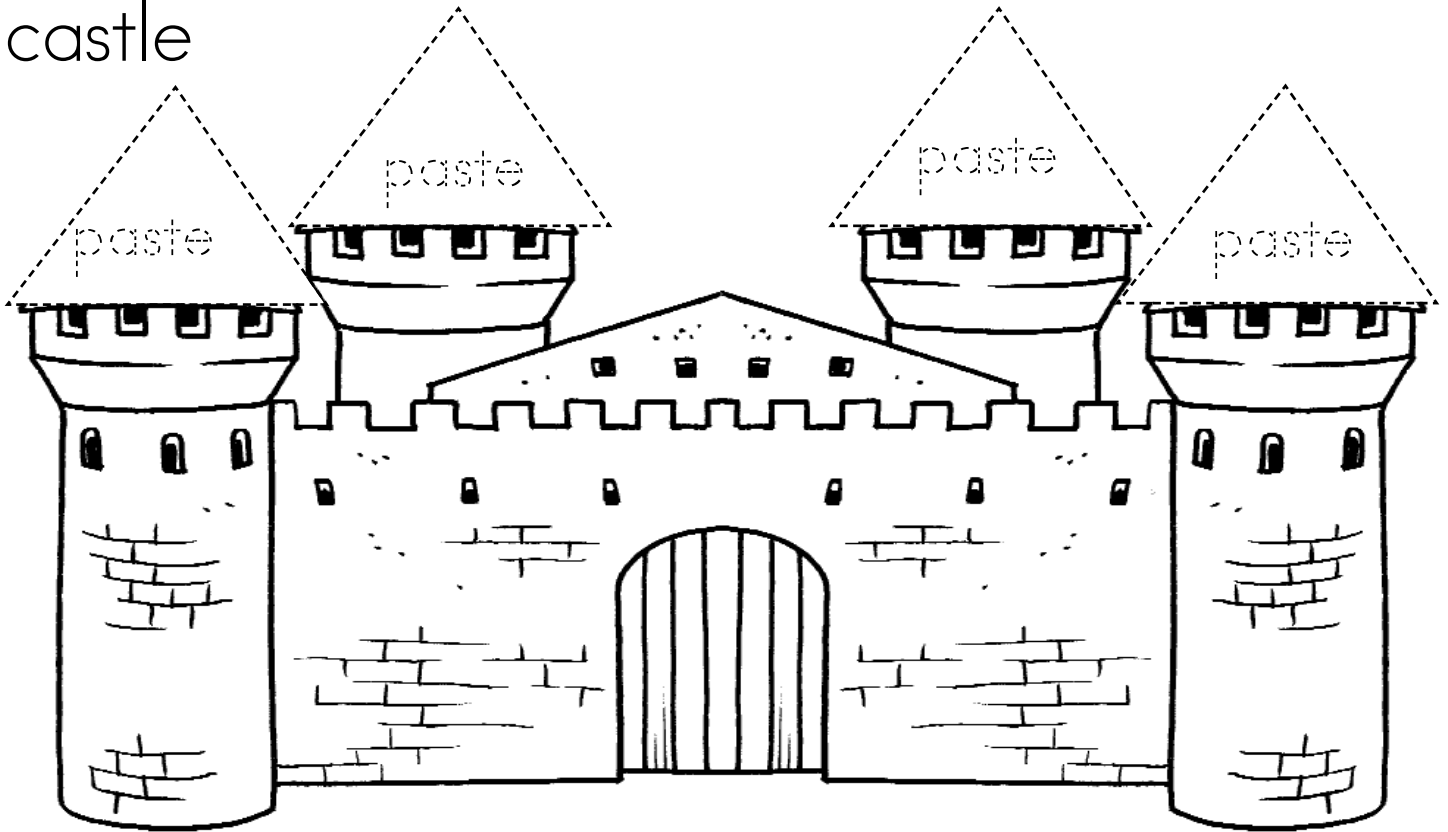

Name _____





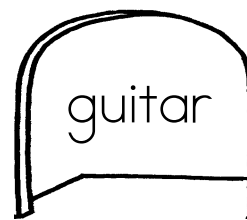
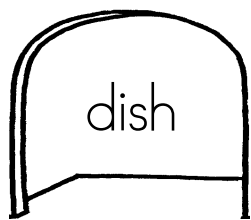
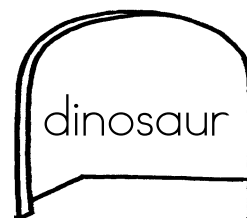
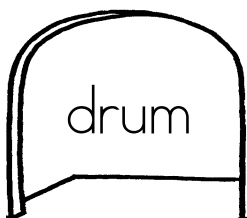
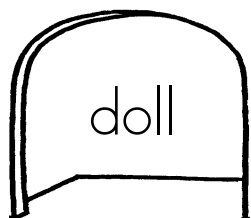
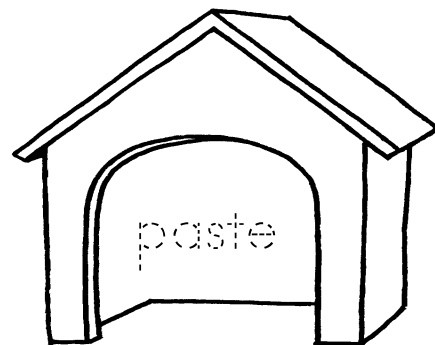
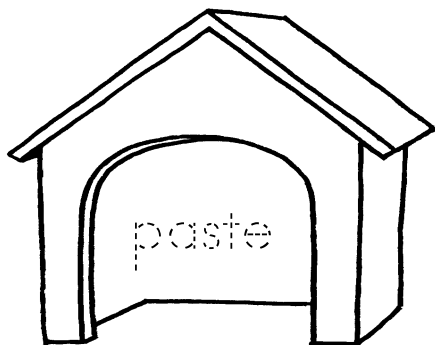
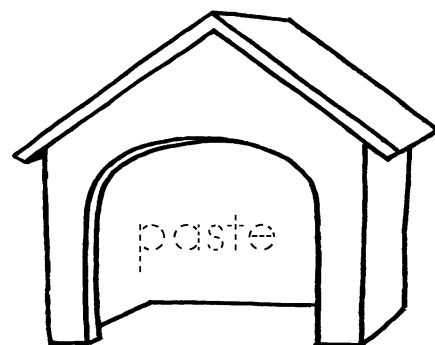
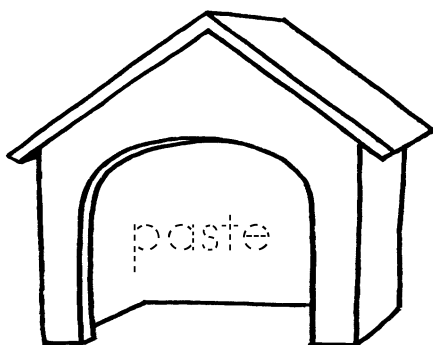
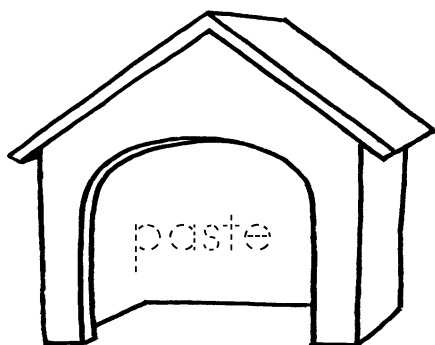

Find a "d" picture for each  and  and  and  each picture that begins with the letter d.

dog houses



Name _____



Find an "e" picture for each  and  and 
and  each picture that begins with the letter e.

eggs

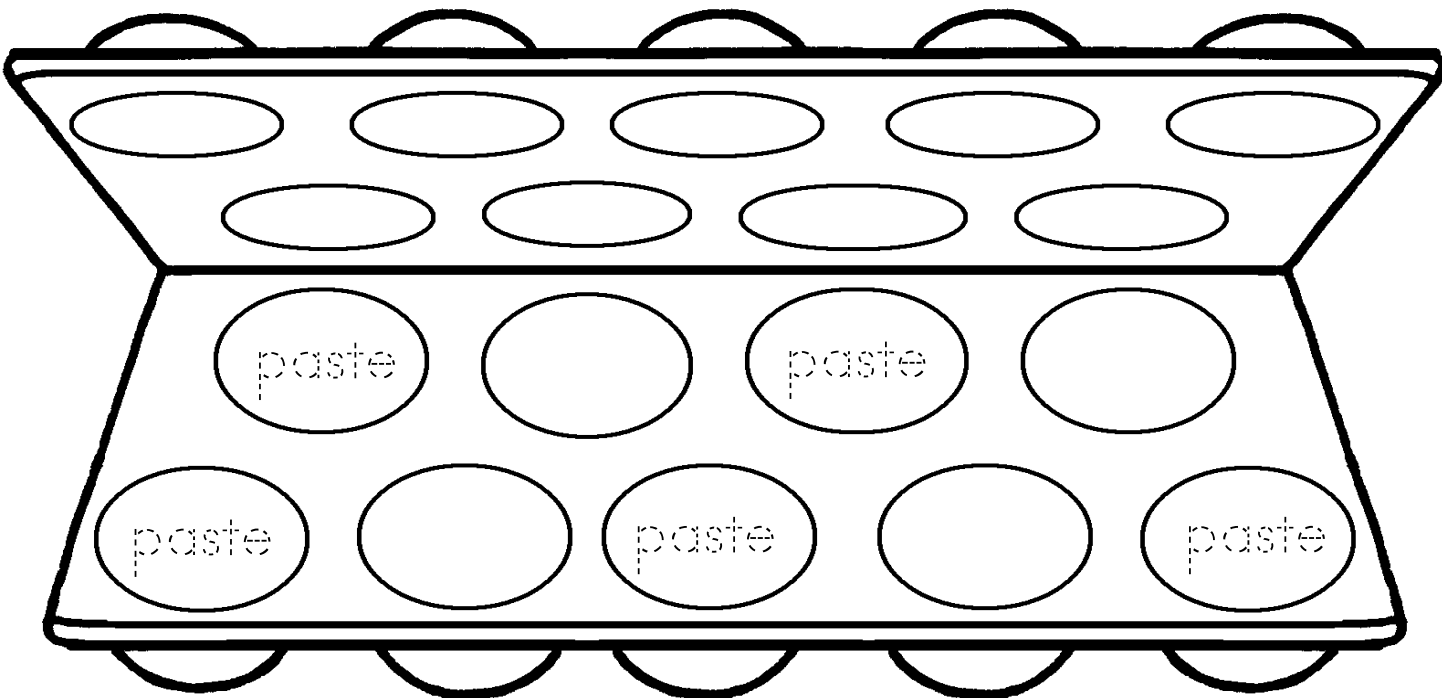

elbow

engine

elf





eggplant

ear

ice cream

Name _____

Ff

Find an "f" picture for each  and  and 
and  each picture that begins with the letter f.

flowers

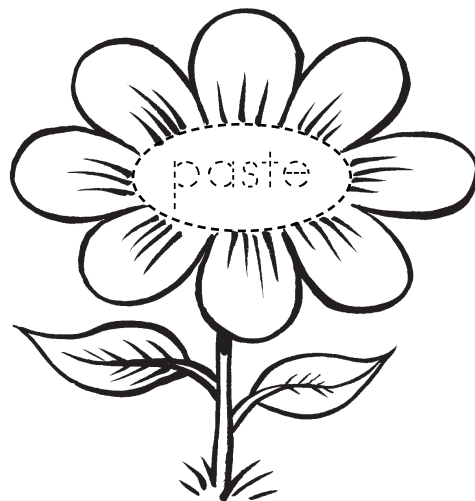
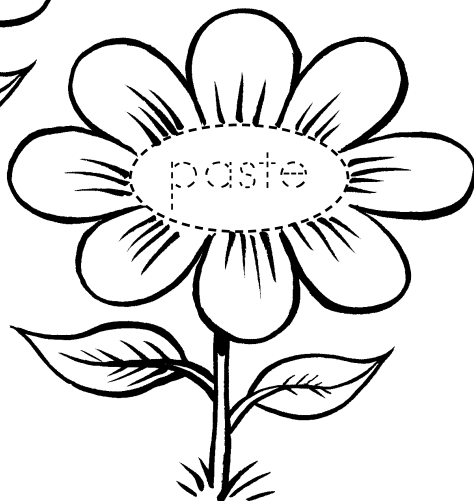
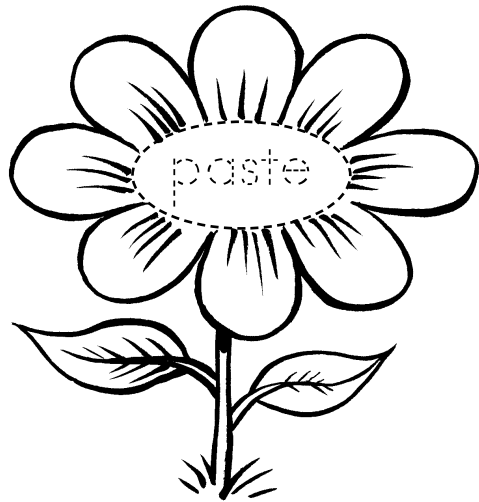
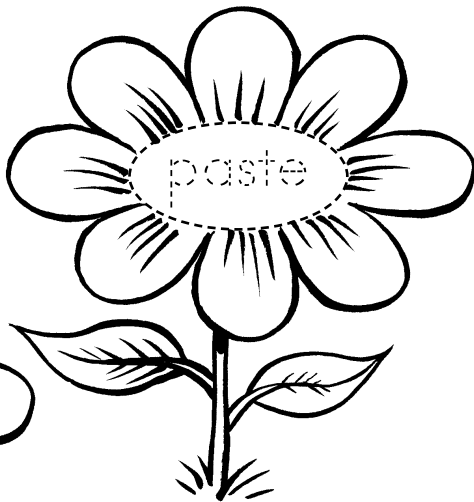
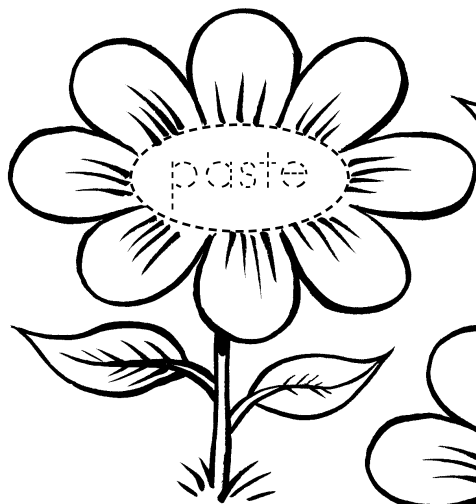

glasses

fish

fly

frog

flag

foot

Name _____

G g



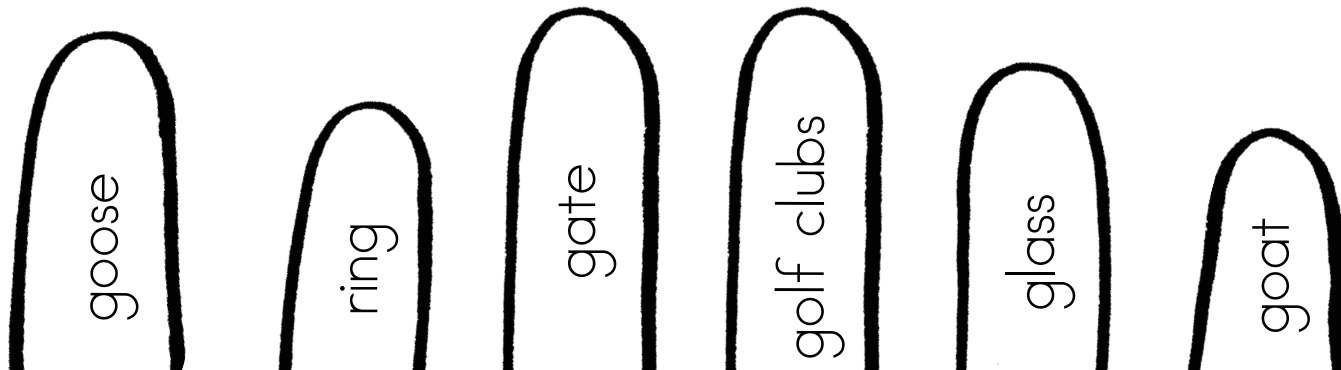
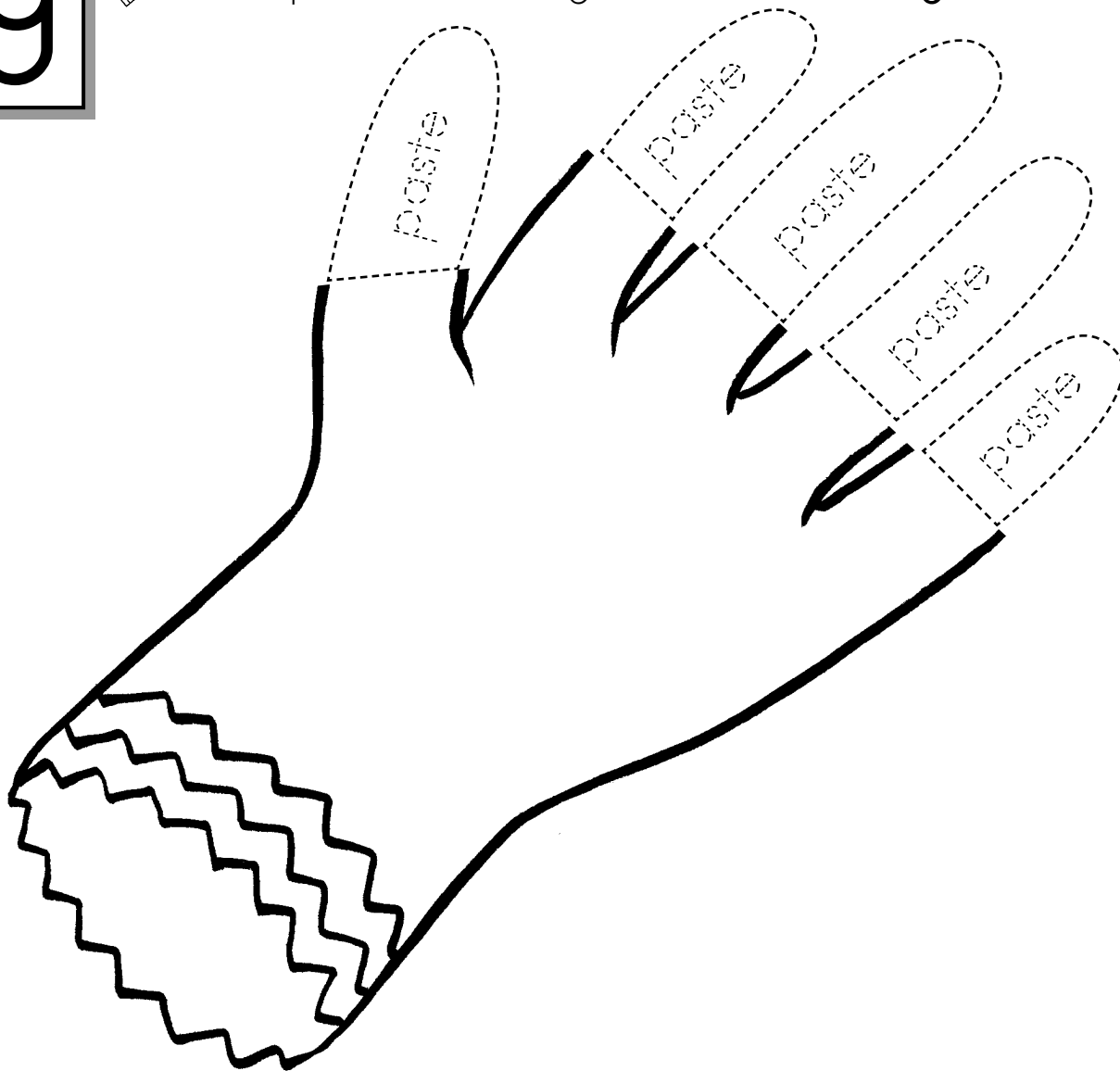

Find a "g" picture for each  and  and  and  each picture that begins with the letter g.

glove



Name _____

H h

Find an "h" picture for each  and  and 
and  each picture that begins with the letter h.

hearts

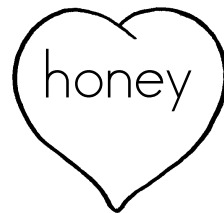
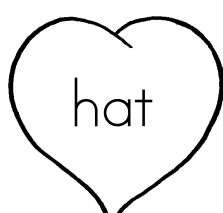
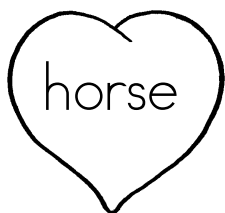
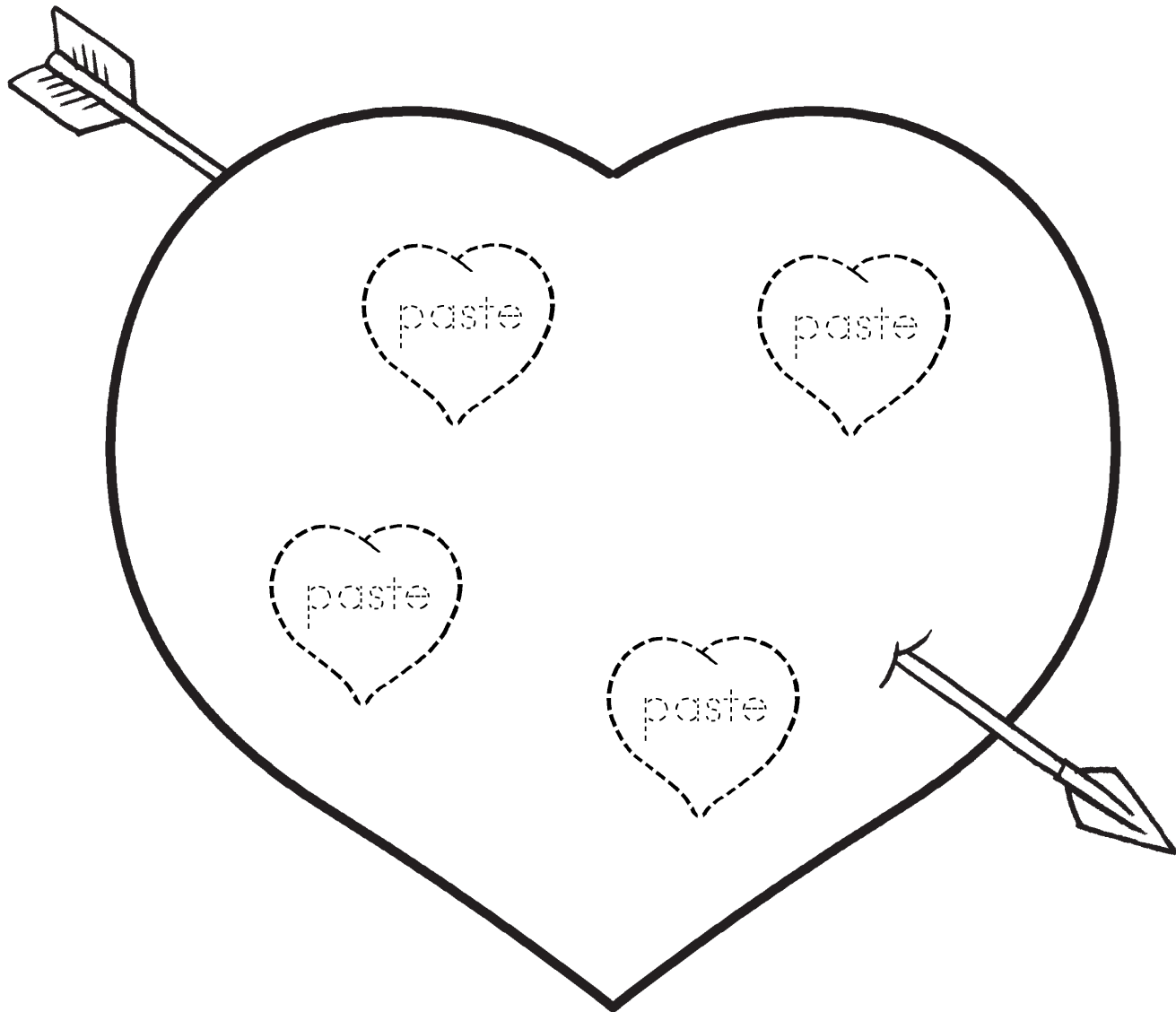

Name _____

I i

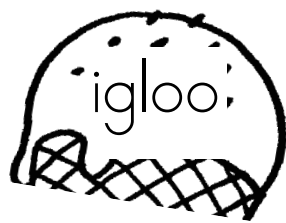
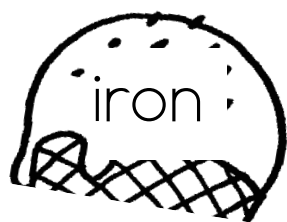
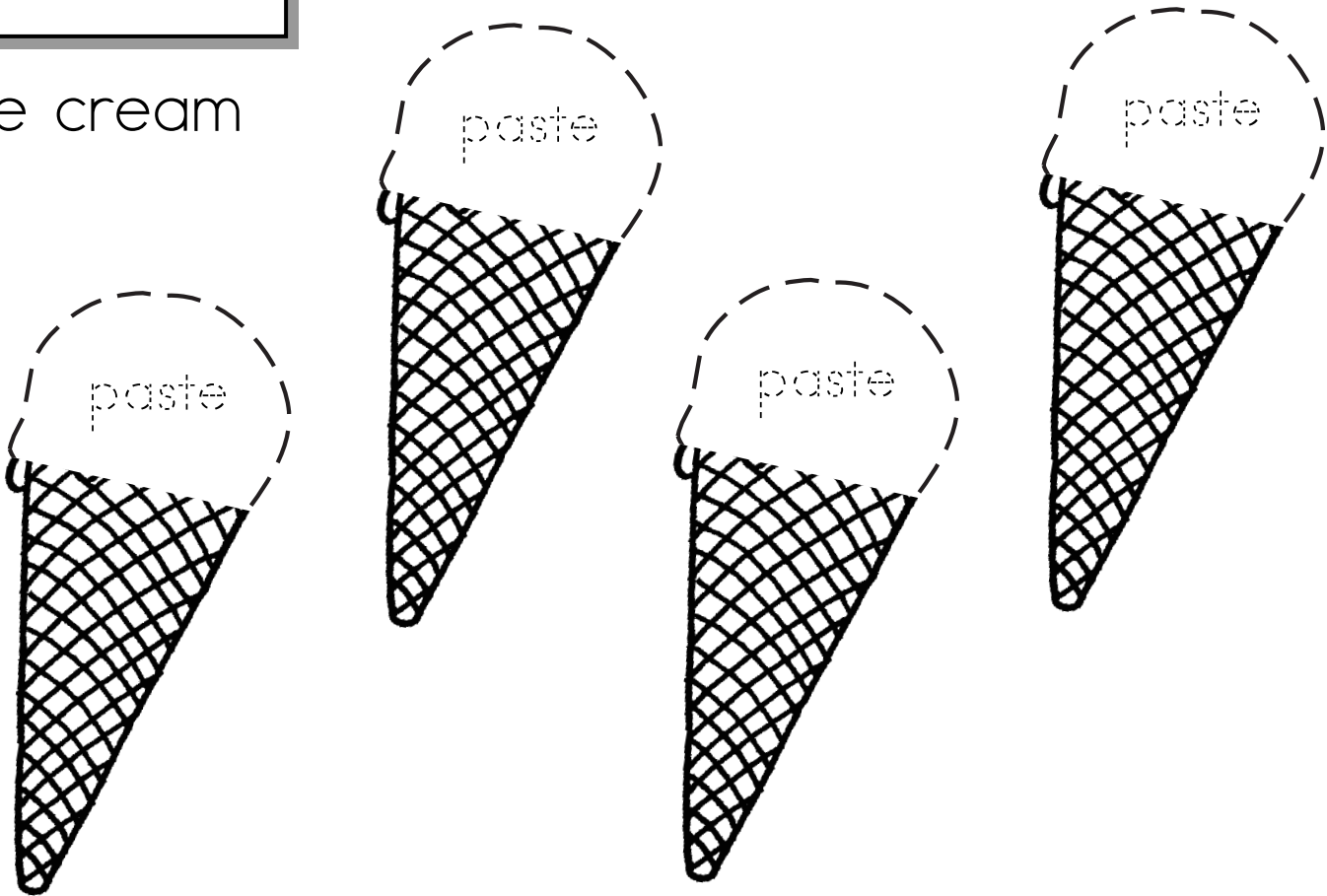

Find an "i" picture for each  and  and 
and  each picture that begins with the letter i.

ice cream



Name _____

Jj

Find a "j" picture for each ○ and  and 
and  each picture that begins with the letter j.

juggle

paste

paste

paste

paste

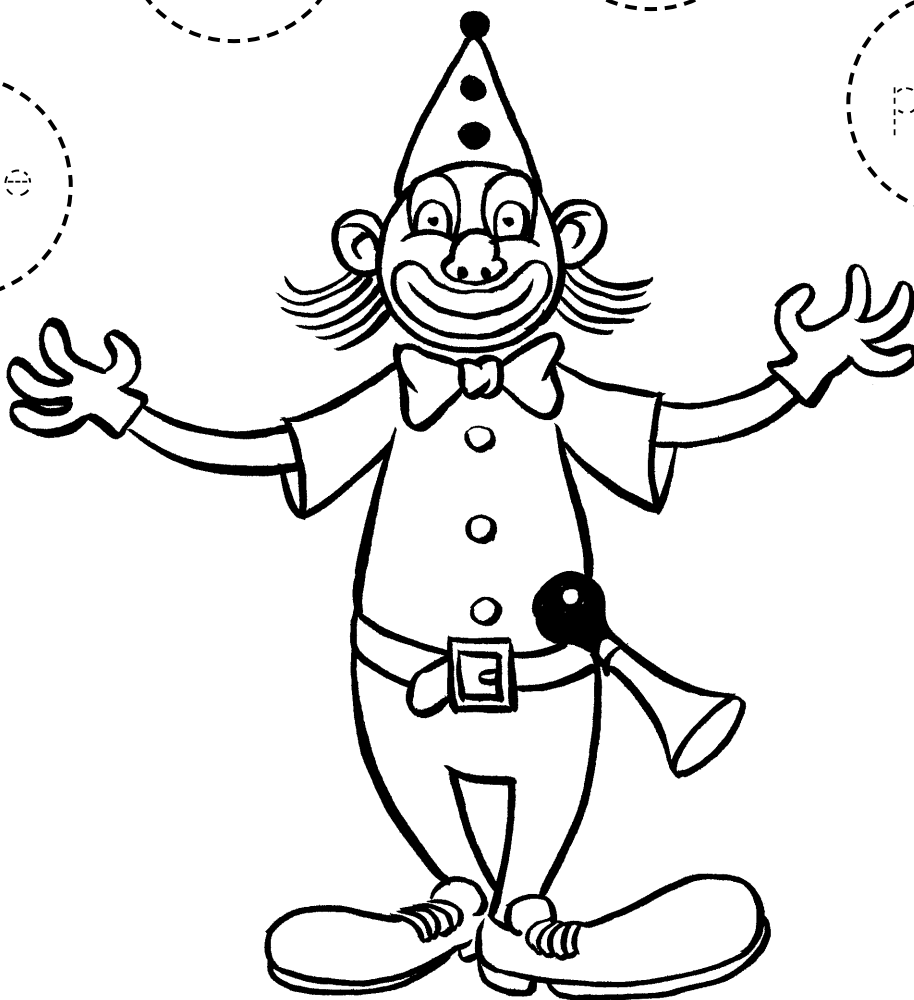

jacks

jump
rope





jet

cat

jacket

Name _____

K k



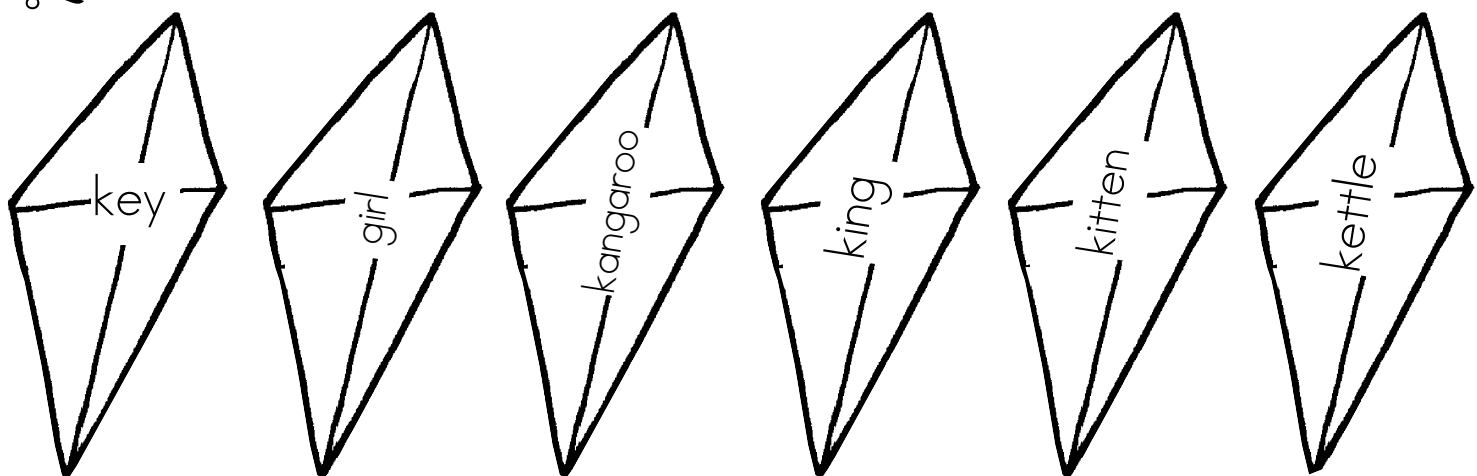
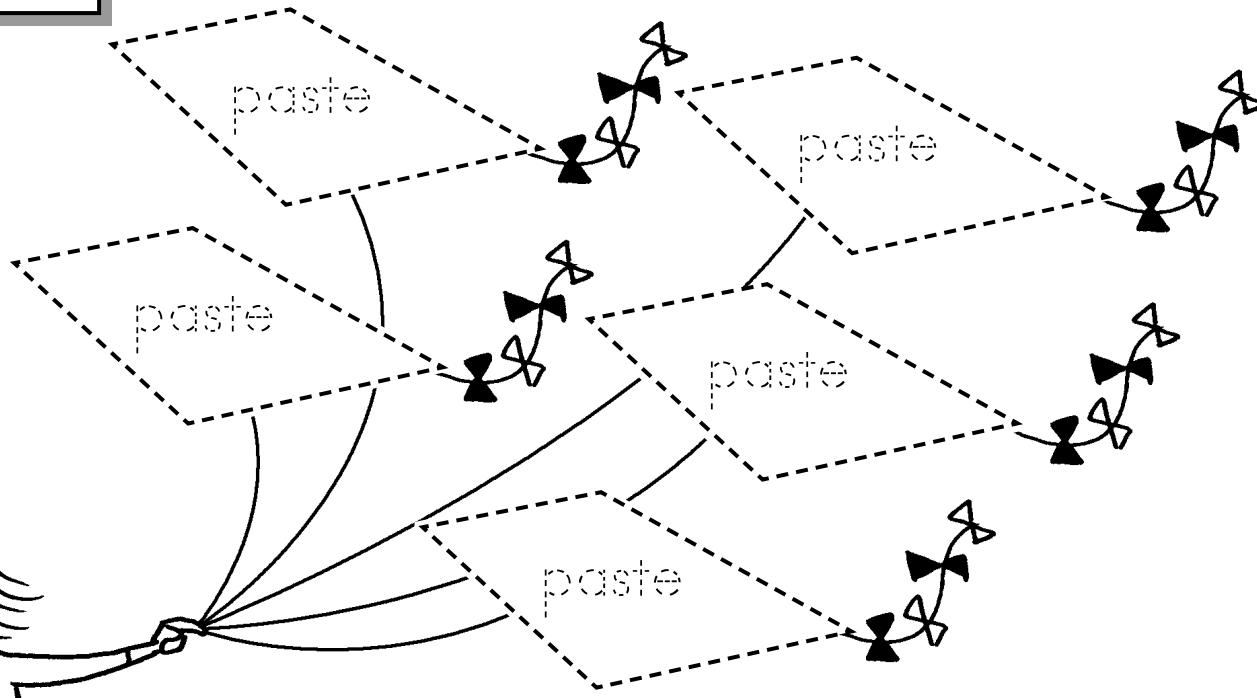

Find a "k" picture for each  and  and 
and  each picture that begins with the letter k.

kite

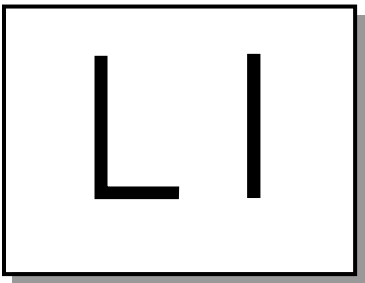

Name _____





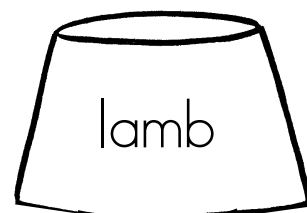
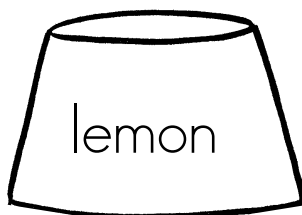
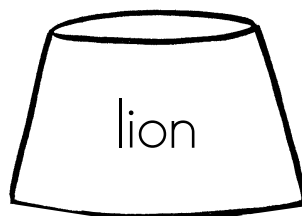
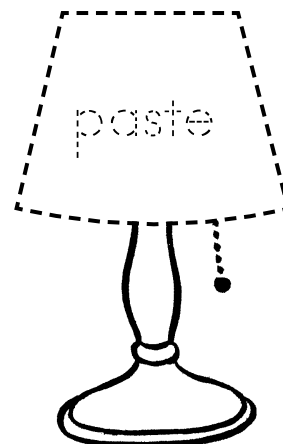
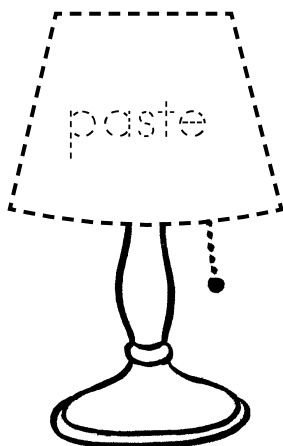
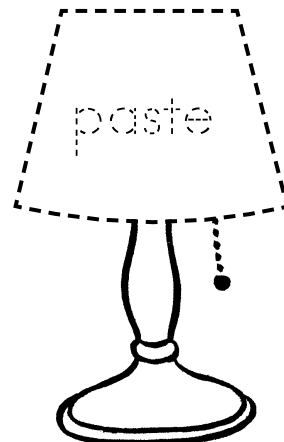
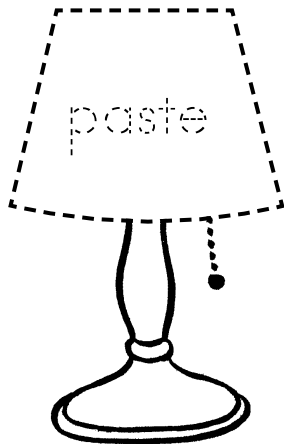
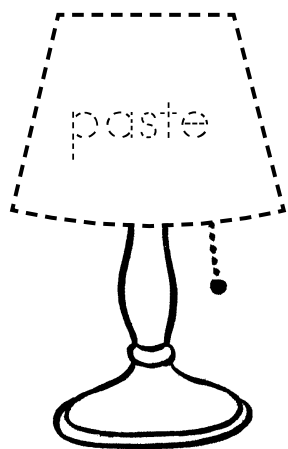

Find an "I" picture for each  and  and  and  each picture that begins with the letter I.

lamps



Name _____

Mm

Find an "m" picture for each  and  and  and  each picture that begins with the letter m.

music

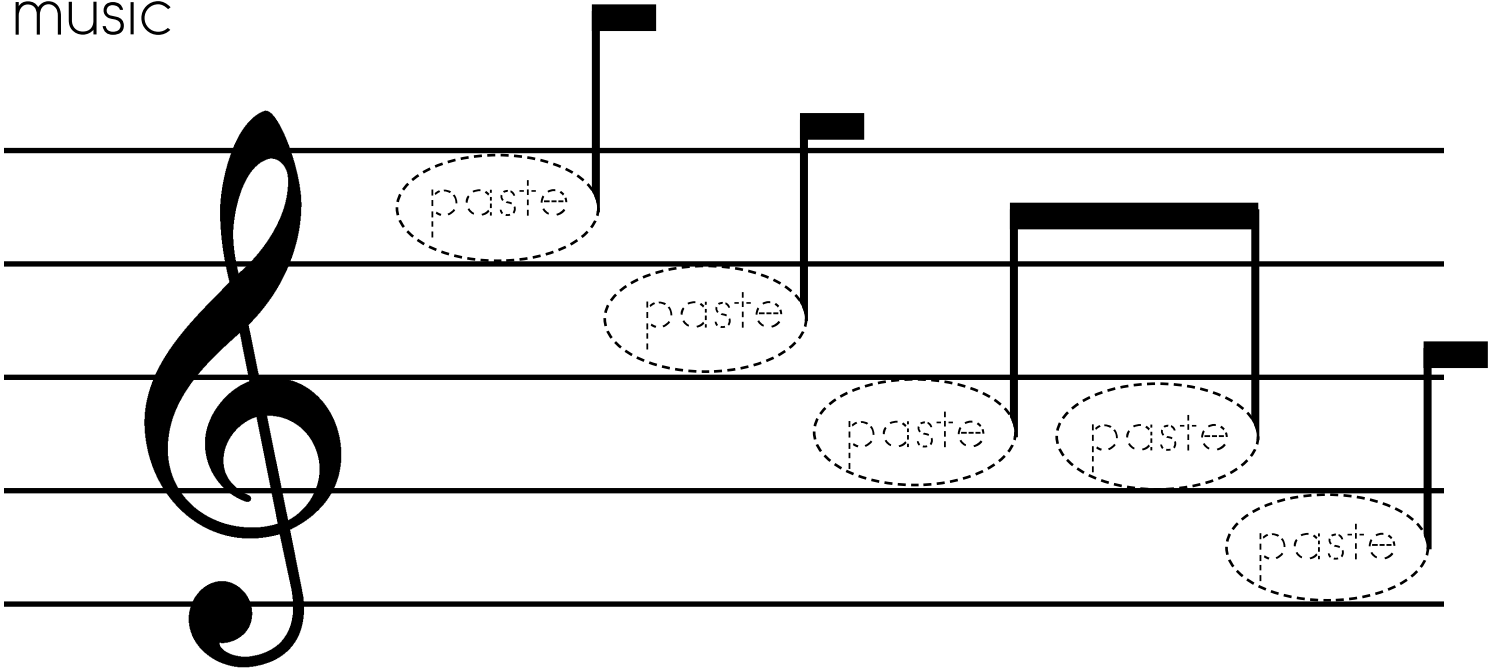

mouse

moon

monkey





kite

mushroom

mailbox

Name _____

N n

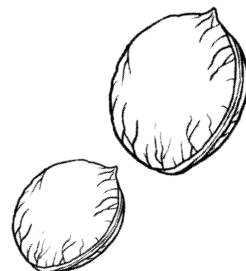
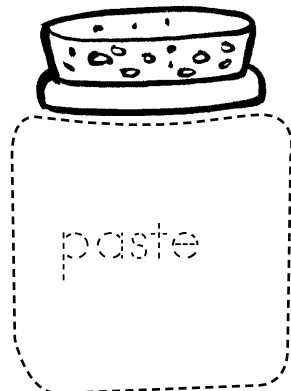
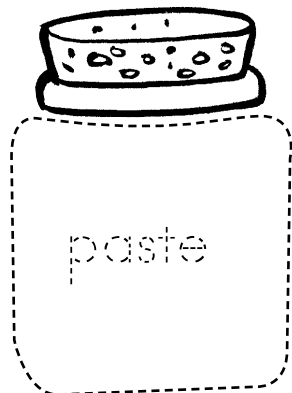
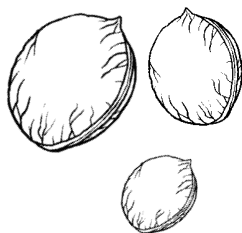
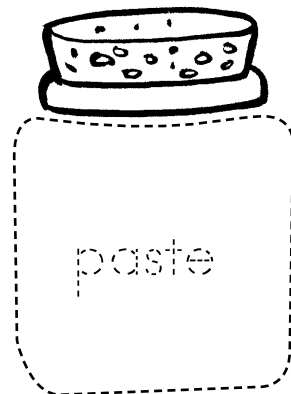
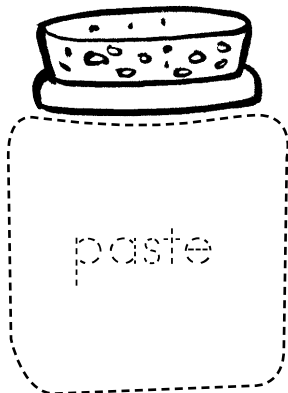
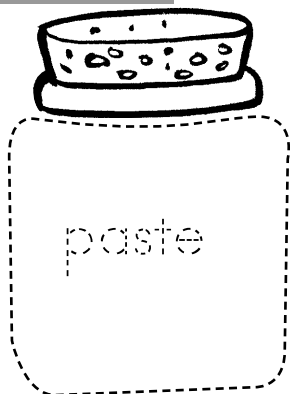

Find an "n" picture for each  and  and  and  each picture that begins with the letter n.

nuts

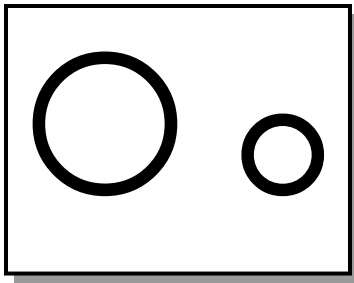

Name _____





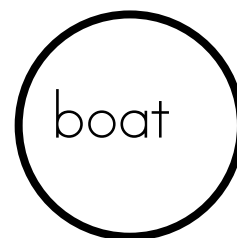
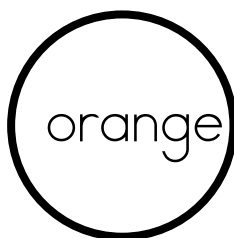
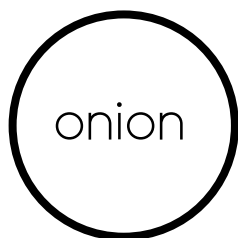
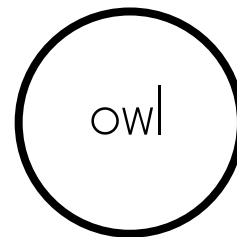
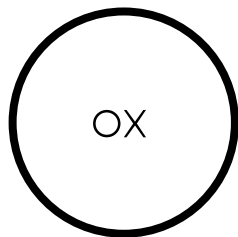
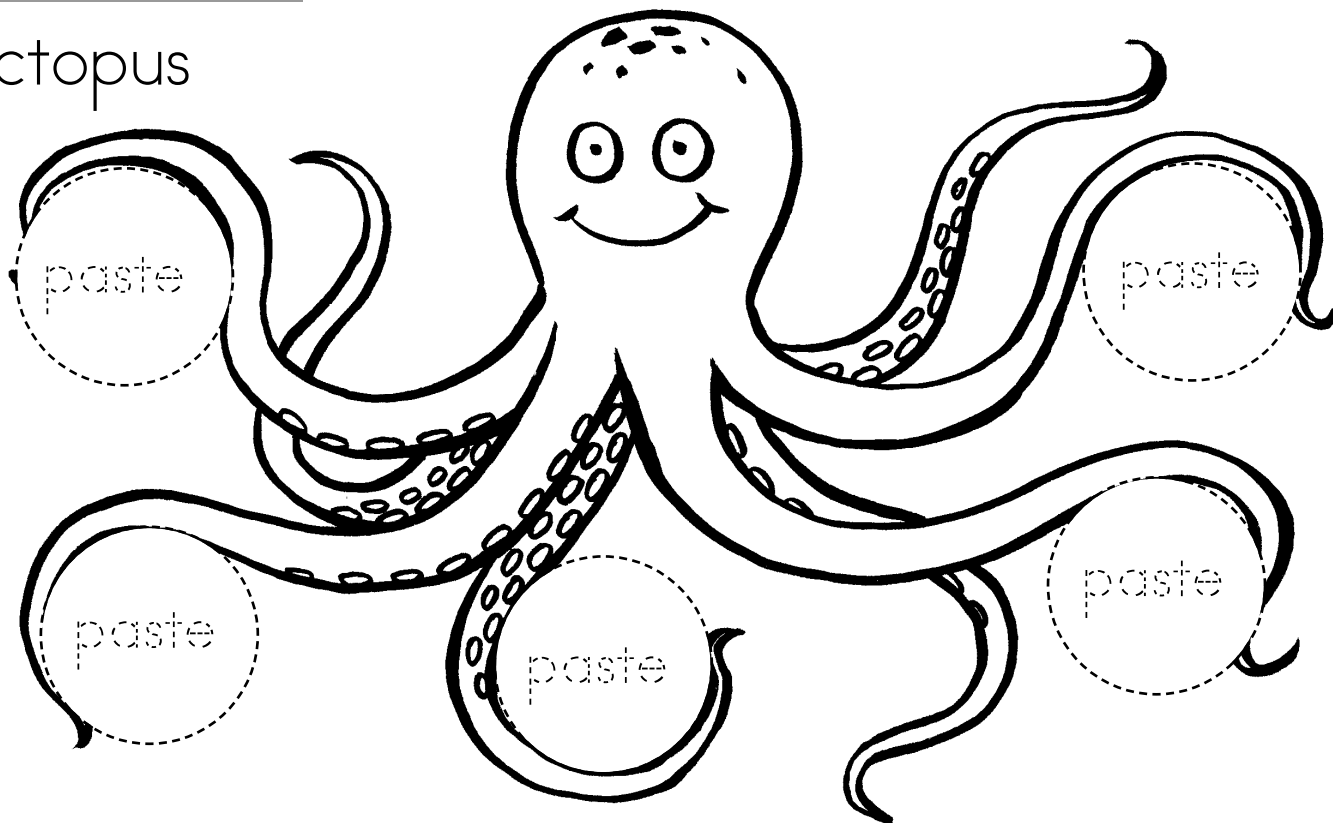

Find an "o" picture for each ○ and  and  and  each picture that begins with the letter o.

octopus



Name _____



Find a "p" picture for each  and  and  and  each picture that begins with the letter p.

piano

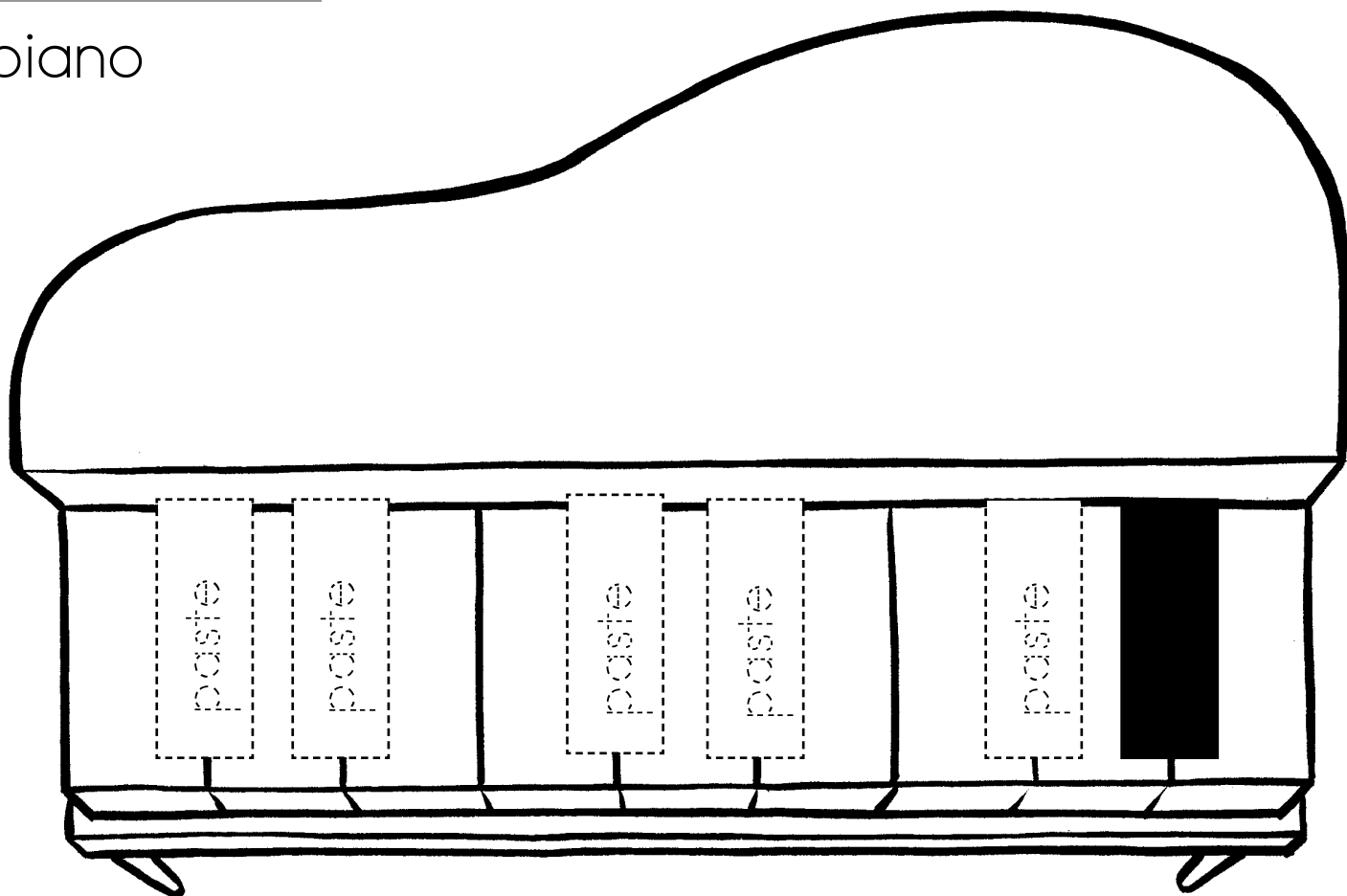

pot

pineapple

umbrella





pizza

pickle

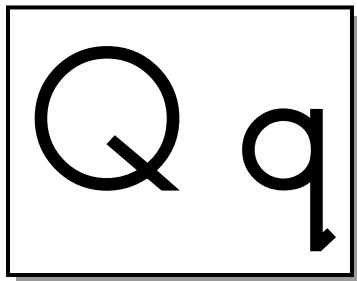
puppy

Name _____



Find a "q" picture for each  and  and  and  each picture that begins with the letter q.

quilt

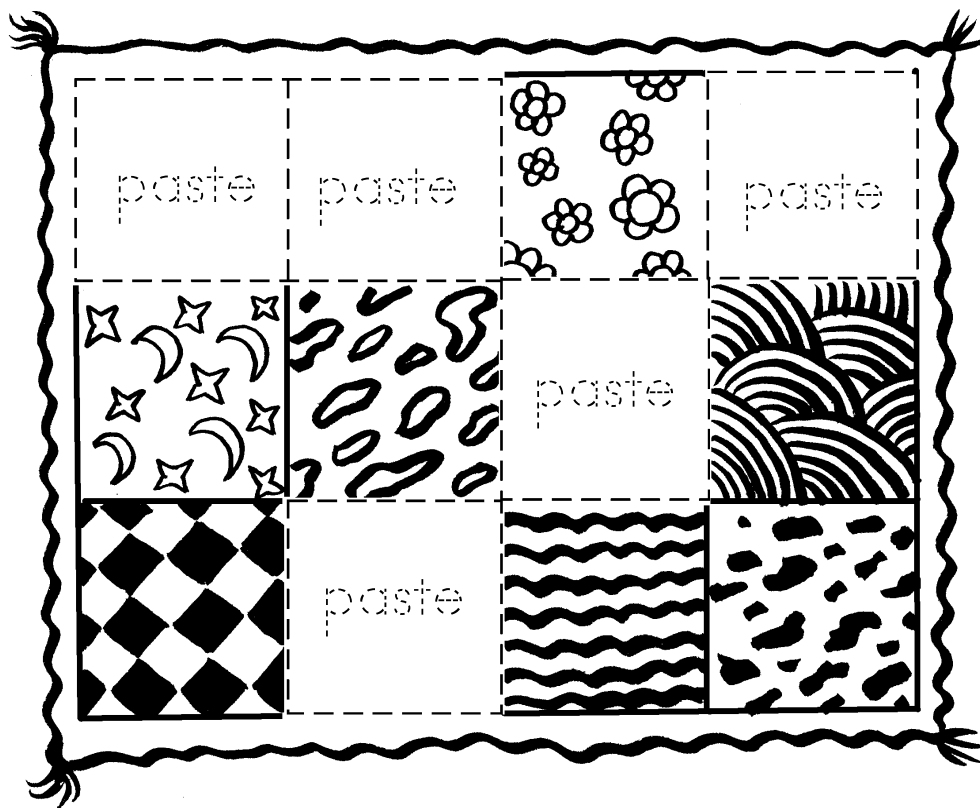

quail

quarter

queen





cookies

quart
of milk

question
mark

Name _____

R r

Find an "r" picture for each  and  and  and  each picture that begins with the letter r.

rabbits

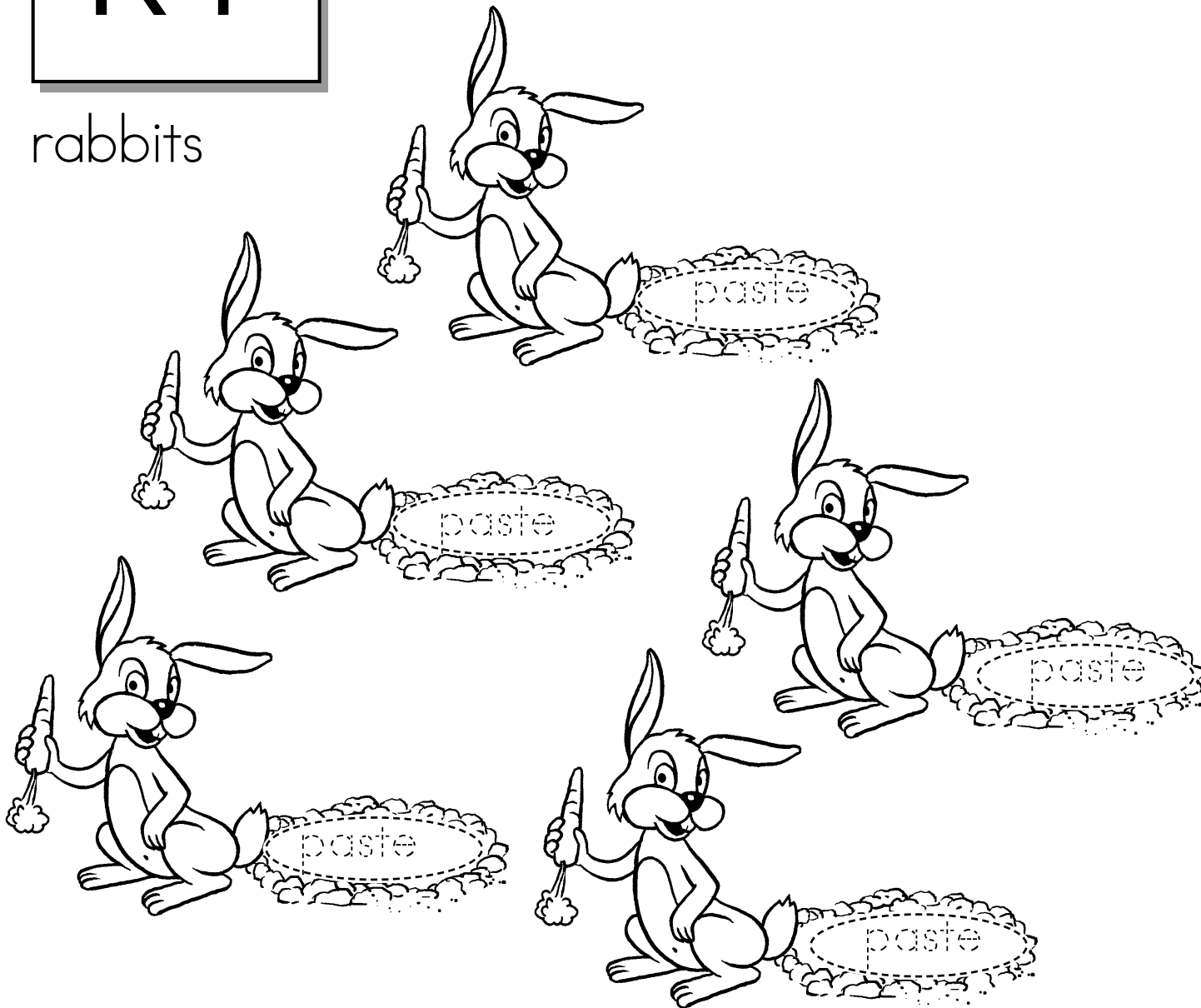

cloud

rain

rake





rose

roller skates

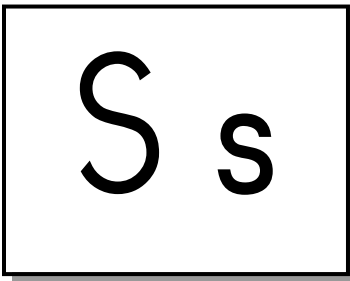
rocket

Name _____





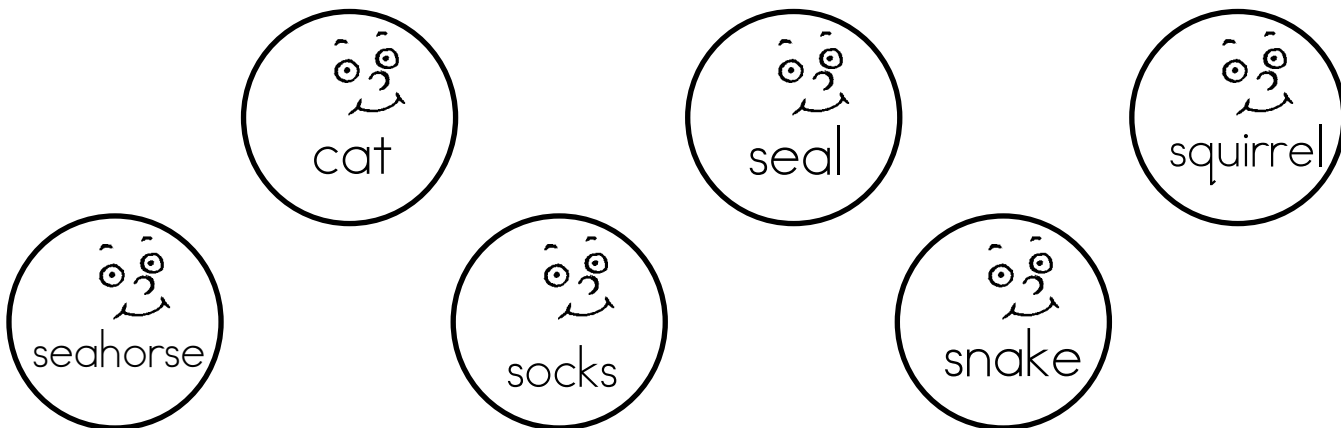
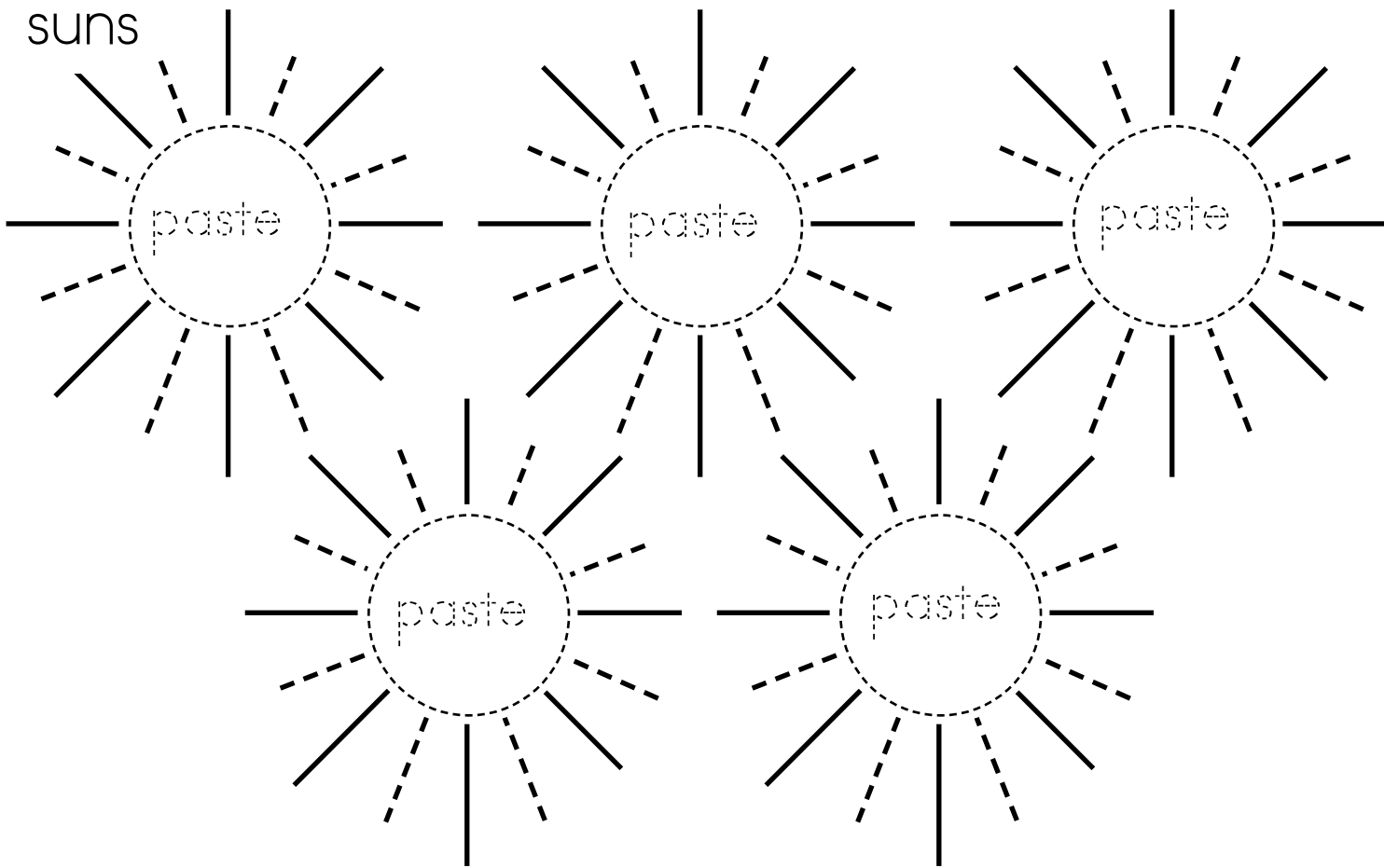

Find an "s" picture for each  and  and  and  each picture that begins with the letter s.

suns

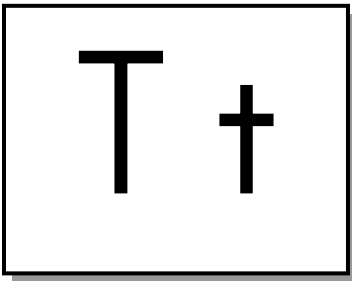

Name _____



Find a "t" picture for each  and  and  and  each picture that begins with the letter t.

televisions

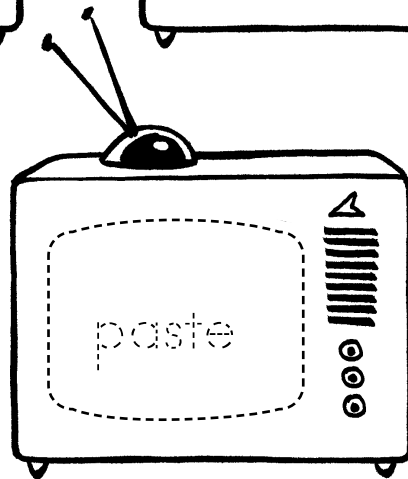
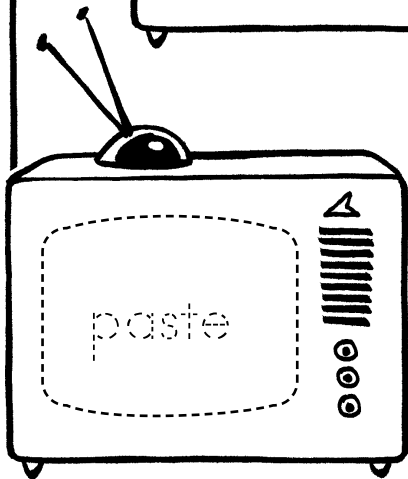
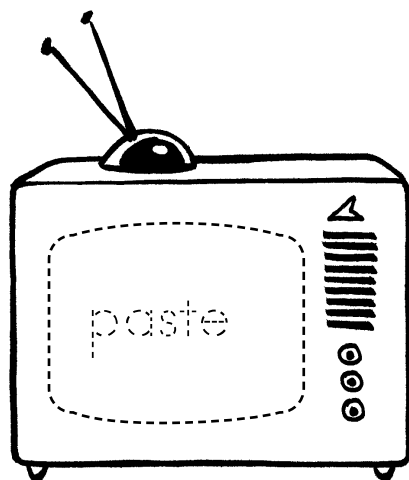
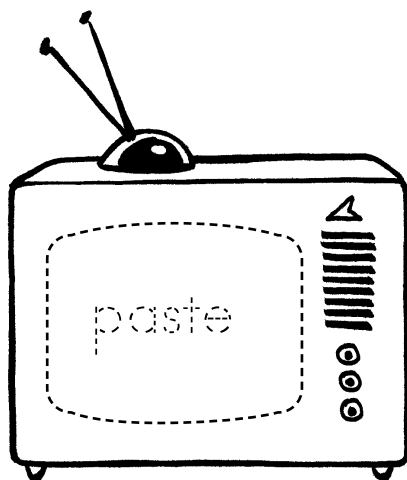
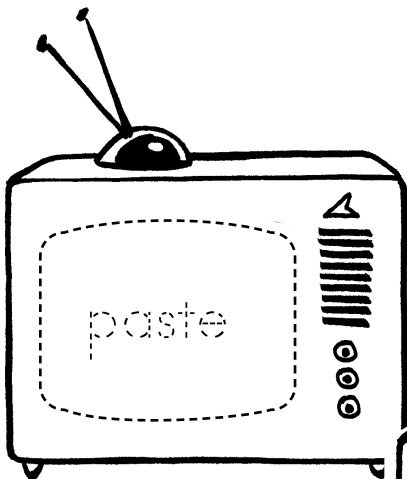

telephone

turtle

toothbrush

tiger

violin

television

Name _____

U u

Find a "u" picture for each  and  and  and  each picture that begins with the letter u.

umbrellas

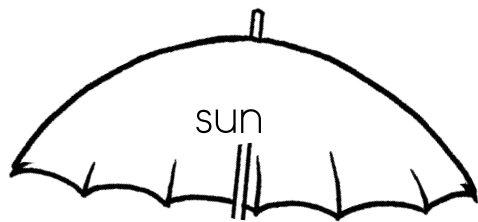
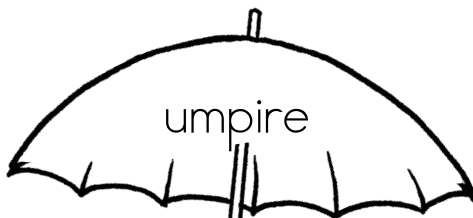
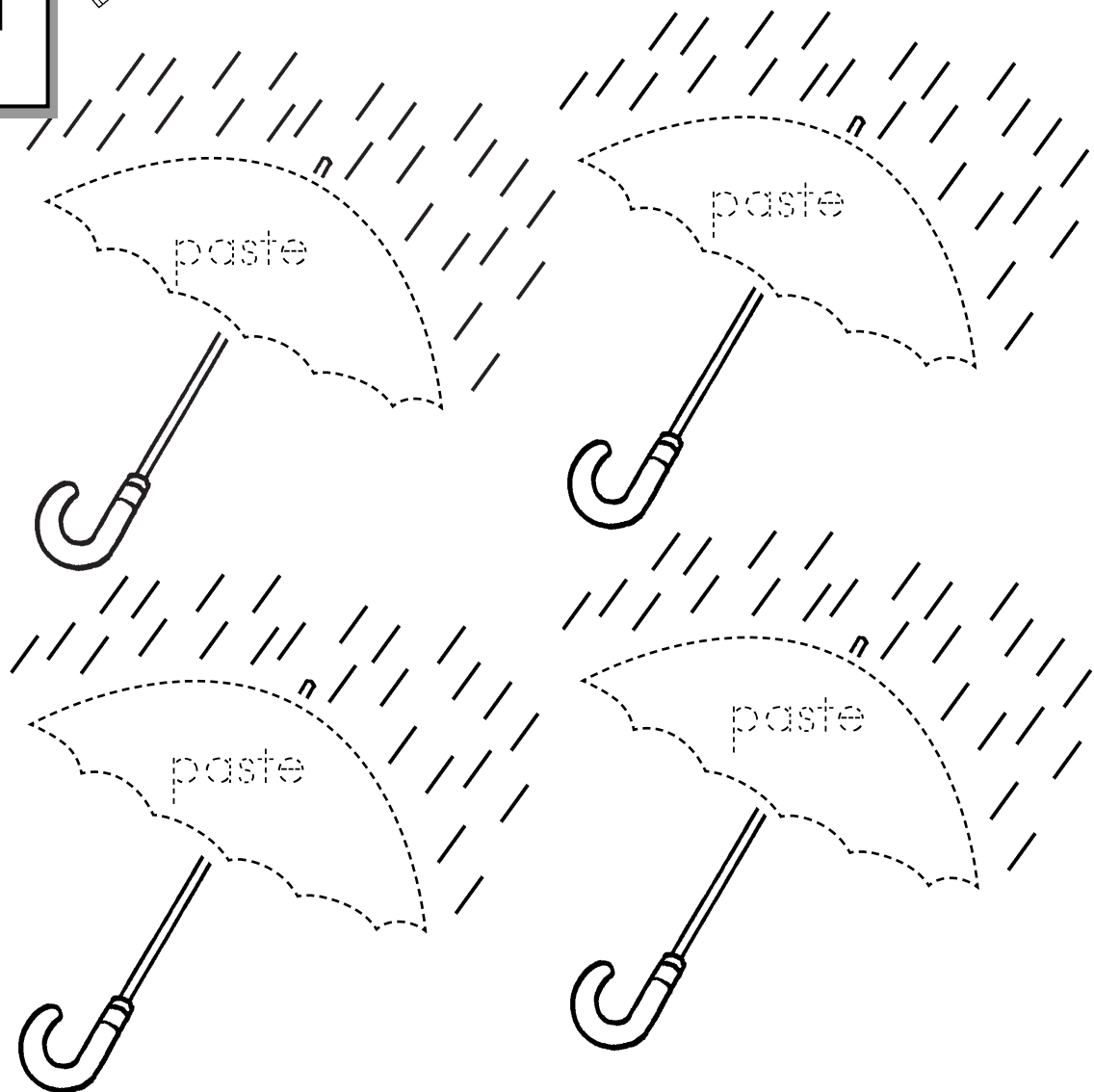

Name _____





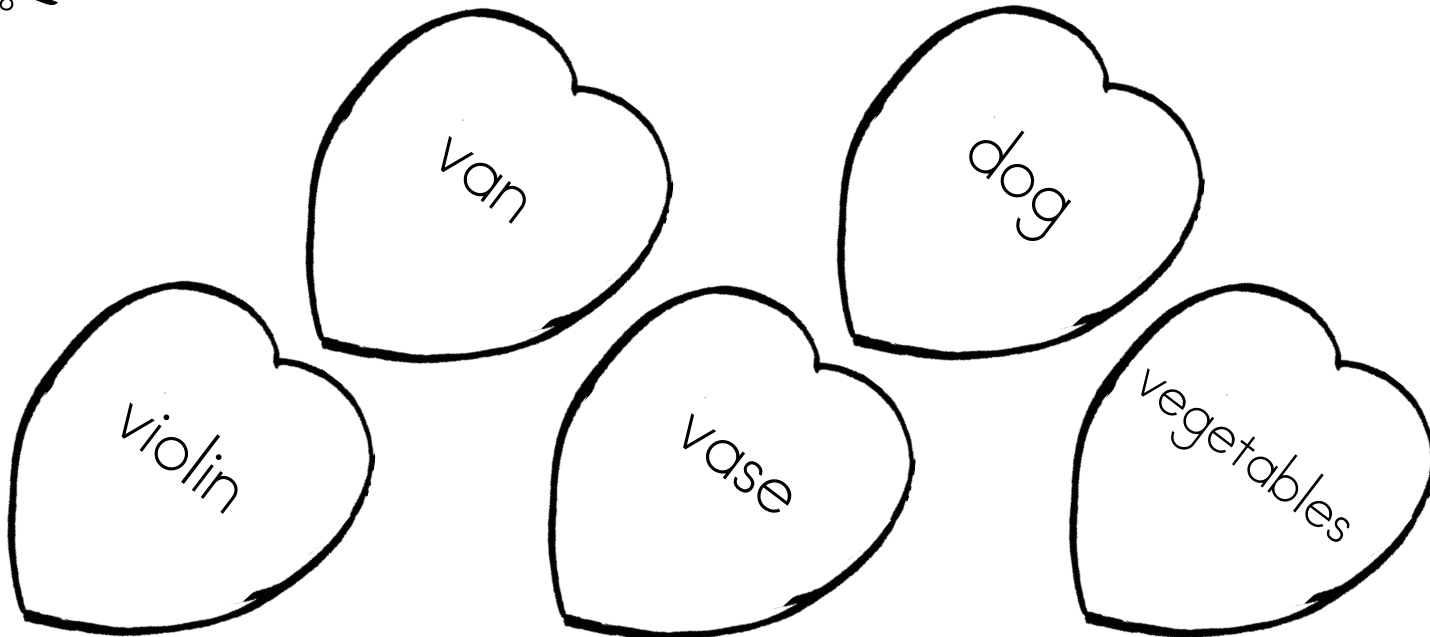
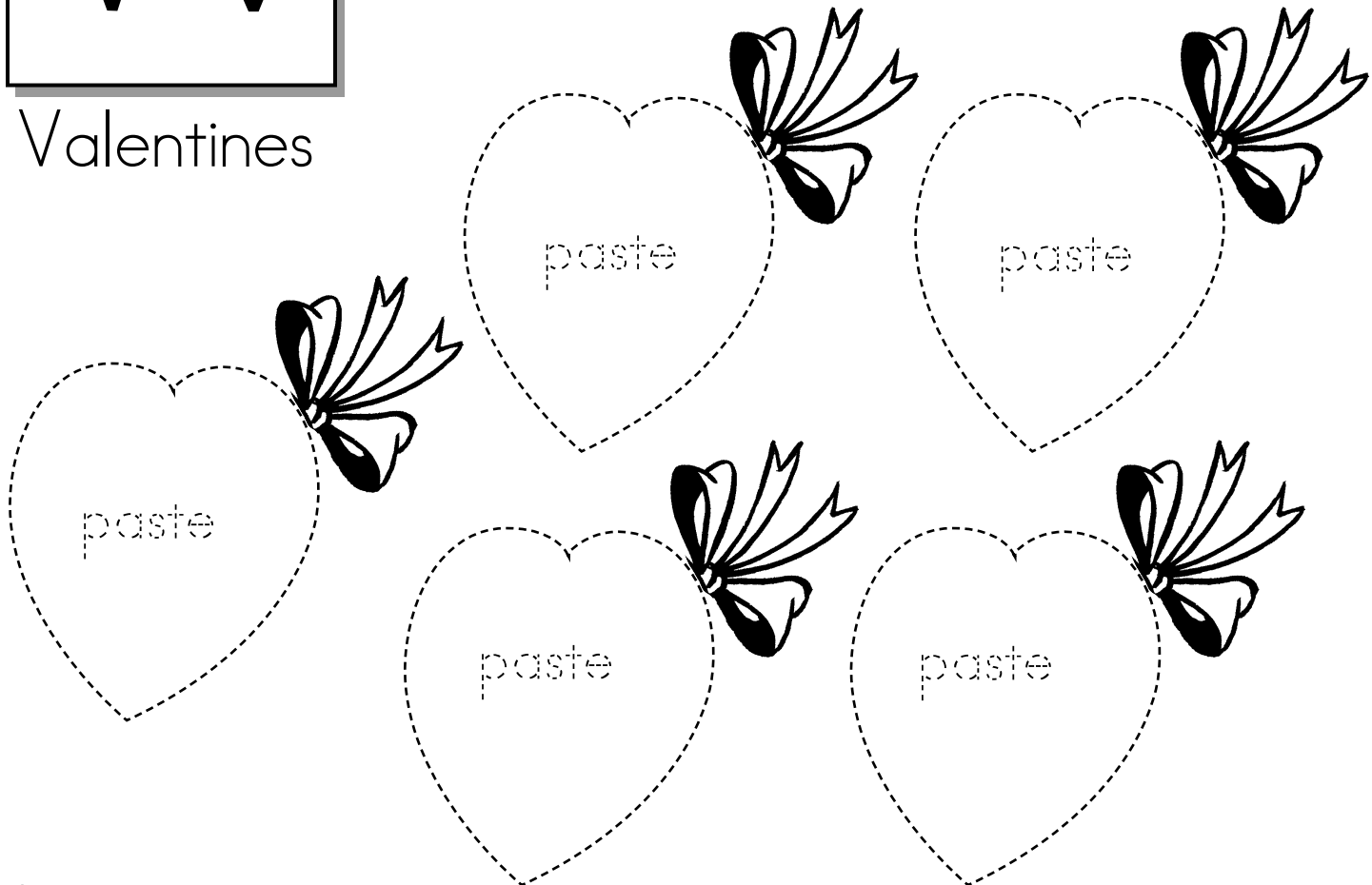

Find a "v" picture for each  and  and  and  each picture that begins with the letter v.

Valentines



Name _____





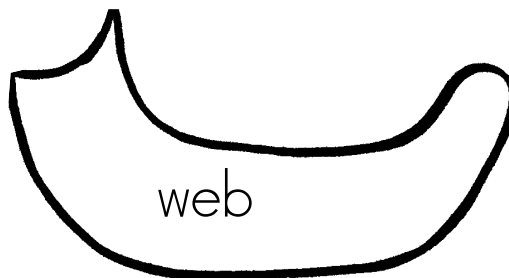
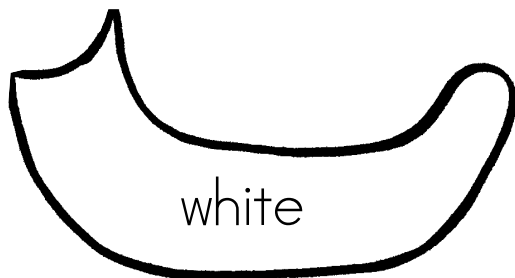
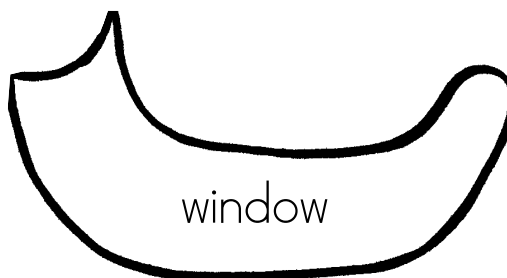
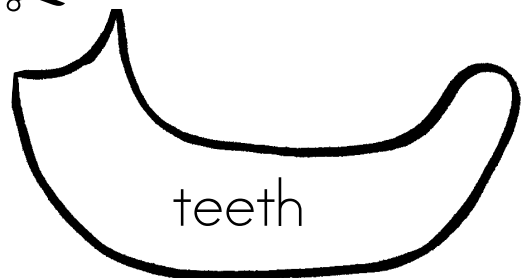
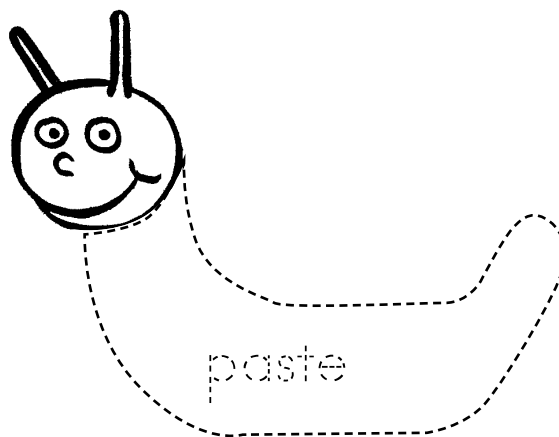
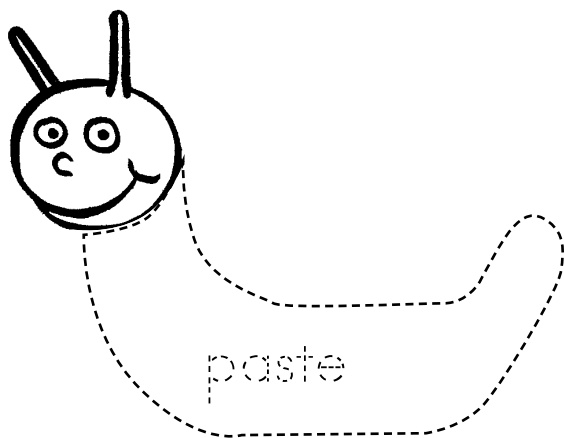
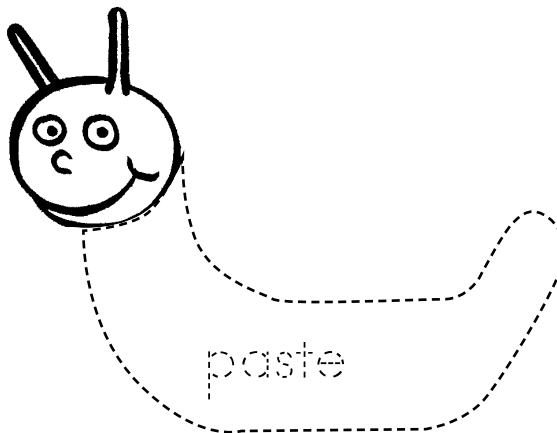

Find a "w" picture for each  and  and  and  each picture that begins with the letter w.

worms

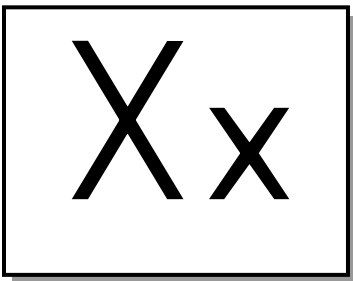

Name _____





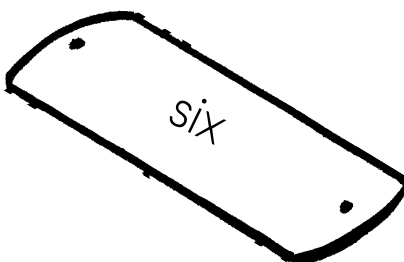
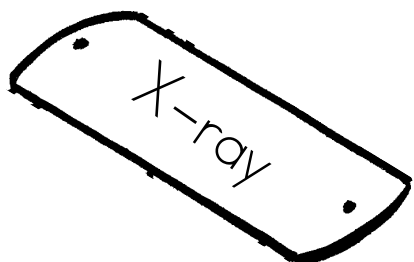
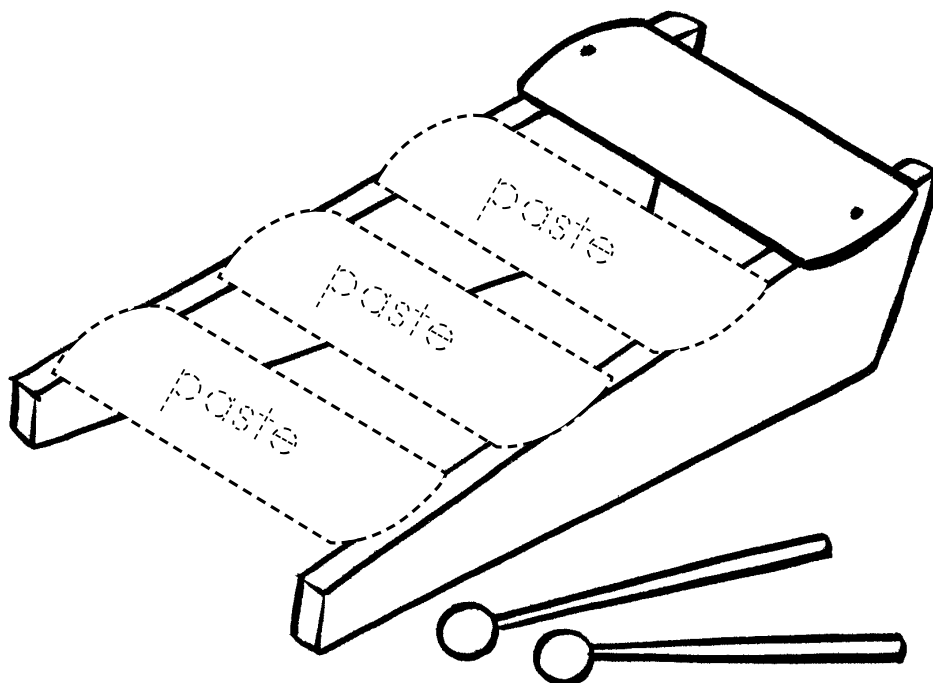

Find an "x" picture for each  and  and  and  each picture that has the letter x.

xylophone

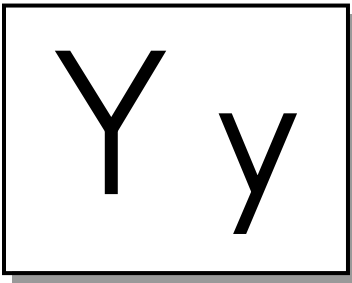

Name _____



Find a "y" picture for each  and  and  and  each picture that has the letter y.

yo-yo

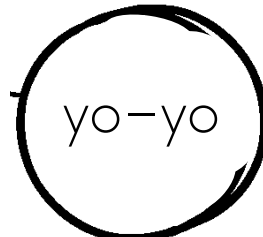
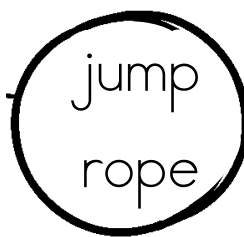
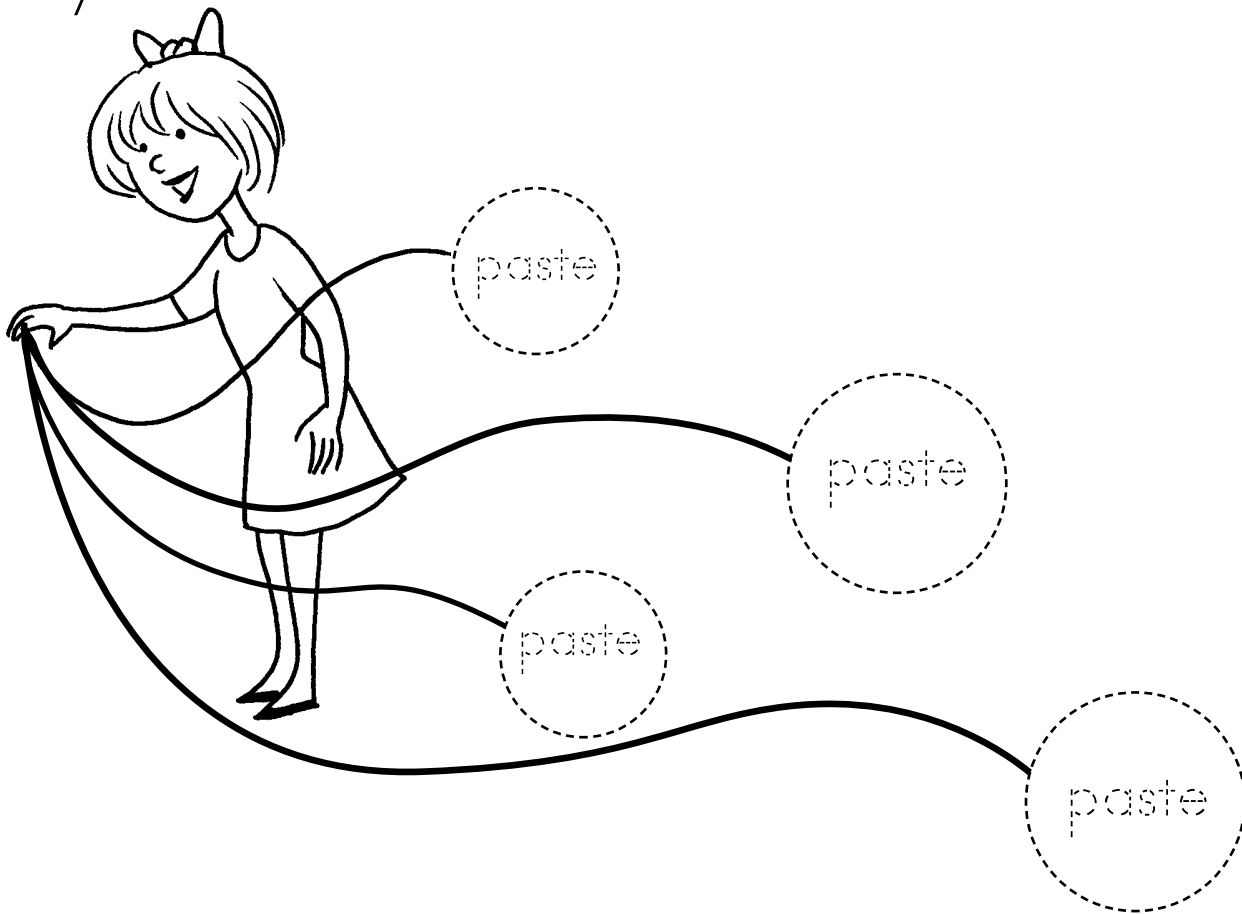

Name _____

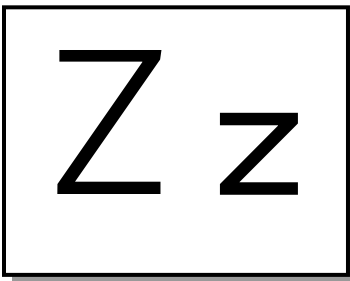

Find a "z" picture for each  and  and  and  each picture that has the letter z.

ZOO

